

FX-STP Pump Quick Start Instruction

Thanks for choosing Kamoer FX-STP pump ideal for calcium reactor; which is a low flow and high precision stepper motor peristaltic pump, with high precision, with screen display, low noise, free maintenance and other advantages.

For the latest information about this product and the support service information for the product, please visit www.kamoer.com.

Packing list

Main unit * 1, Power adapter * 1, Connector * 2, Tube * 2, Instruction * 1, QC certificate * 1

How to Connect

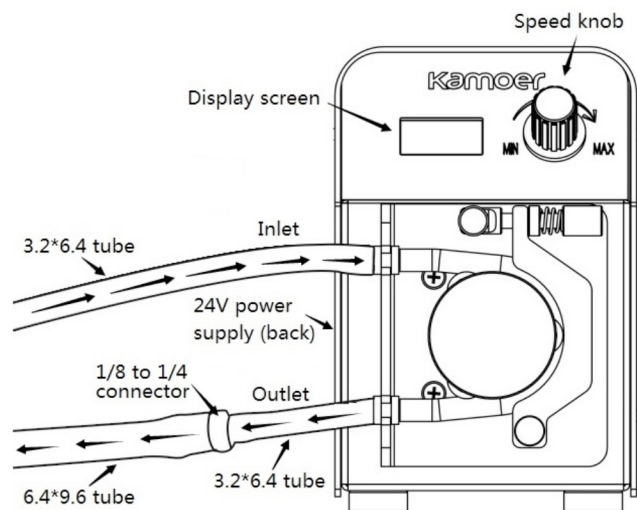

Kamoer Fluid Tech (Shanghai) Co., Ltd reserves the right to improve or alter appearance and technical specifications without notice.

How to Use

1 Run Mode

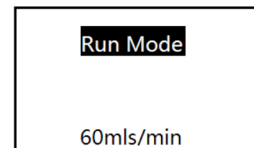

A) Power on and wait for startup ends. Click the knob to start pump running and press the knob again to stop pump running.

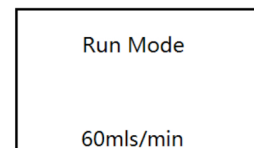

B) Clockwise rotating the knob to increase the flow rate and counterclockwise rotating knob to reduce the flow rate when pump running.

Note: When the set flow rate exceeds a certain speed, it will run at low speed for 30 seconds (the screen displays "Low speed") and then accelerate to the set speed ("Low speed" disappears).

2 Calibration

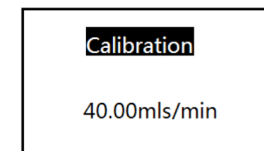

A) In the pump stop state, rotate the knob to the calibration interface.

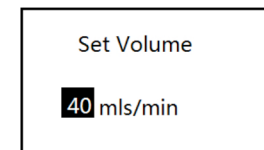

B) Click on the knob to enter the calibration flow input interface. Rotate the knob to the desired flow rate and press the knob again to start the calibration.

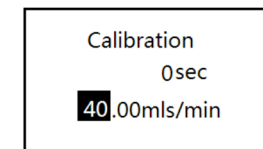
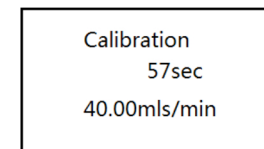

C) Wait for the 60 second countdown to end, input the actual volume of liquid.

Note: If the difference between the set calibration flow rate and actual flow rate is larger, repeats A, B, C steps until both are the same.